

M-X30 / M-X50 / M-X70

MASTED FORKLIFT TRUCKS



M-X30 / M-X50 / M-X70

3 models to choose from



M-X 30

3 tons



M-X 50

5 tons



M-X 70

7 tons



MANITOU: AT YOUR SIDE ON ANY CONSTRUCTION SITE

The M-X range is Manitou's most established range. Unparalleled in the market, this range was developed with more than **50 years of working experience, innovations, and listening to our users.**

Known for their **durability** and **performance** even on the steepest sites, the all-terrain Manitou forklift trucks go where others do not!

In combining **simplicity** and **productivity**, the new M-X30, M-X50 and M-X70 forklift trucks are essential allies for your construction sites.

The **power** and the **manageability** of the M-X allow you to perform your job **effectively** and **safely**.

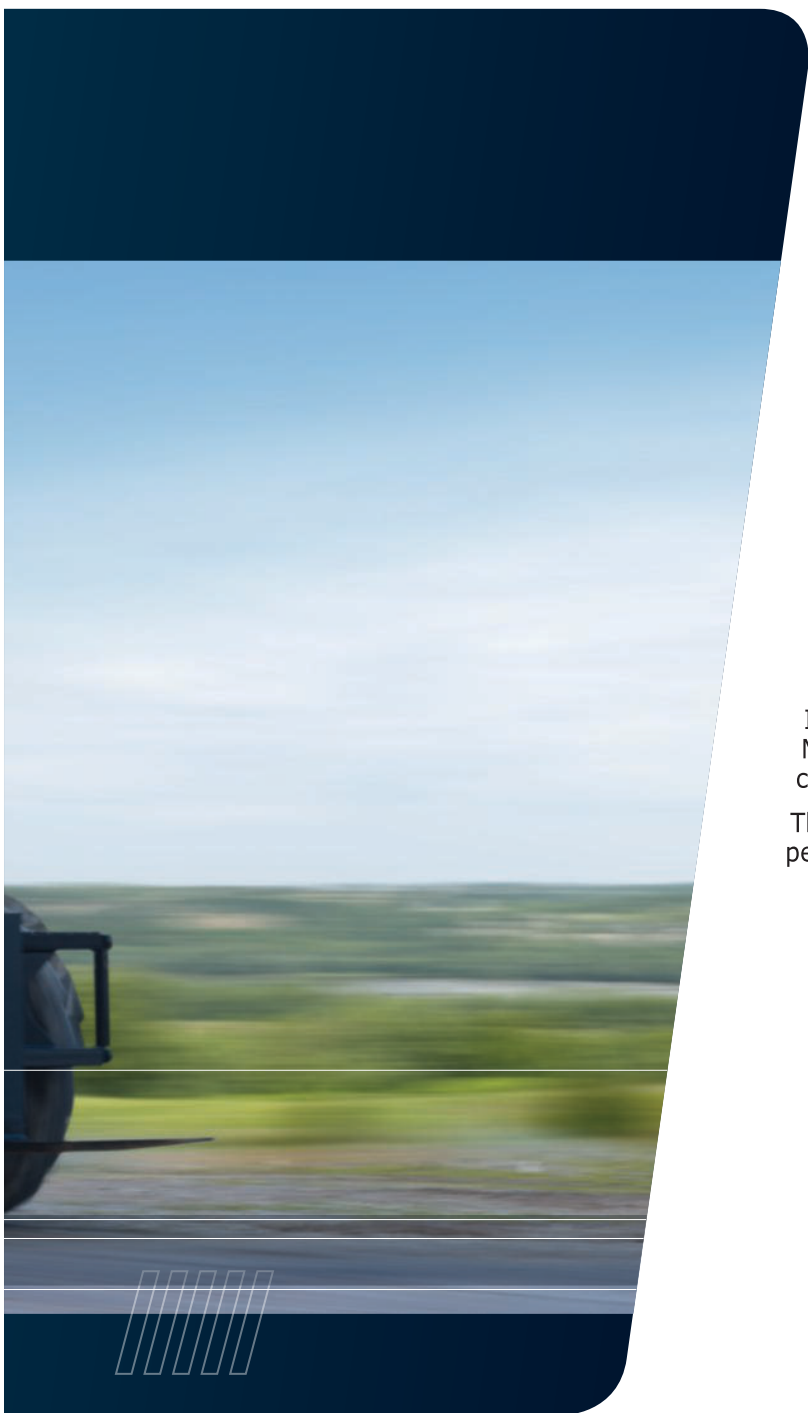

SIMPLICITY

Simplified **USAGE** and **MAINTENANCE**

COMMONALITY across all models



Spacious cab with a panoramic view

- Full vision cab with optional doors which can be securely folded back.
- Suspended cabin reducing vibrations for the operator.
- Efficient heating and ventilation as standard, air conditioning (optional).

Ergonomic levers

The user benefits from being ideally positioned to use the controls which are naturally located within easy reach.



Very tight turning radius
4.10 m





EASE OF MAINTENANCE

whatever the model
When the bonnet is **fully open** complete access **can be gained** to the engine, gauges, filters and lubricators, to reduce the maintenance time and to help prevent downtime.

PANORAMIC VIEW: 360° VISIBILITY



QUICK AND SAFE ACCESS

via a large door and a non-slip step

SHOCK ABSORBER

As standard, Shock Absorber technology keeps the load stable no matter the state of the ground on which you are manoeuvring.



PRODUCTIVITY

PERFORMANCE and STURDINESS

Power 95 HP

STAGE 3A Engine.
Torque 392 Nm.
4 cylinders.
4.4l engine size.



Flexible Transmission

The torque converter transmission allows the operator to choose between the speed of movement on smooth surfaces or additional torque for operating on steeper gradients (4 Speed Gearbox).

Lifting height up to

6 m



Exceptional all terrain capability

Large diameter front wheels with good load distribution on both axles with central differential locking system.

Rear axle can move through a wide angle



Optimal stability

Its **width** ensures the forklift truck has better stability for extra safety for lateral loading.



Monobloc frame fully resistant to torsional stress when operating on rough terrain.

Mast reclines up to

15°



Up to **40 cm**

Good ground clearance

MANITOU masts, recognised quality for over 50 years!

















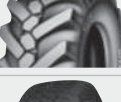

MASTS

M-X 30 / M-X 50 / M-X 70

| | Forklift type | Mast (m) | Free lift (mm) | Height of mast fully retracted (mm) | Height of mast extended (mm) | Height with Max Capacity. (m) | | Capacity at Max. Height (kg) | |
|--------------------------------|---------------|----------|----------------|-------------------------------------|------------------------------|-------------------------------|-------------------------|------------------------------|-------------------------|
| | | | | | | Including sideshift | Not including sideshift | Including sideshift | Not including sideshift |
| Full visibility duplex | M-X 30 | 3.00 | 130 | 2305 | 4045 | 3.00 | 3.00 | 3000 | 3000 |
| | M-X 50 | | - | 2560 | 4115 | | | 4700 | 5000 |
| | M-X 30 | 3.30 | 130 | 2455 | 4345 | 3.30 | 3.30 | 3000 | 3000 |
| | M-X 50 | | - | 2710 | 4415 | | | 4700 | 5000 |
| | M-X 30 | 3.50 | 130 | 2555 | 4545 | 3.50 | 3.50 | 3000 | 3000 |
| | M-X 50 | | - | 2810 | 4615 | | | 4700 | 5000 |
| | M-X 70 | 3.60 | - | 3205 | 5005 | 3.60 | 3.60 | 6300 | 7000 |
| | M-X 30 | 3.70 | 130 | 2715 | 4745 | 3.70 | 3.70 | 3000 | 3000 |
| | M-X 50 | | - | 2910 | 4815 | | | 4700 | 5000 |
| | M-X 30 | 4.00 | 130 | 2905 | 5045 | 4.00 | 4.00 | 3000 | 3000 |
| | M-X 50 | | - | 3060 | 5115 | | | 4700 | 5000 |
| | M-X 70 | | - | 3405 | 5405 | | | 6300 | 7000 |
| | M-X 30 | 4.50 | 130 | 3155 | 5545 | 4.00 | 4.00 | 2800 | 2900 |
| | M-X 50 | | - | 3305 | 5615 | | | 4050 | 4500 |
| | M-X 70 | | - | 3655 | 5905 | | | 5850 | 6500 |
| | M-X 30 | 5.00 | 130 | 3405 | 6045 | 4.00 | 4.00 | 2400 | 2600 |
| M-X 50 | - | | 3560 | 6115 | 3600 | | | 4000 | |
| M-X 30 | 5.50 | 130 | 3655 | 6545 | 4.00 | 4.00 | 1500 | 2000 | |
| Free lift duplex | M-X 30 | 3.00 | 1383 | 2305 | 3962 | 3.00 | 3.00 | 3000 | 3000 |
| | M-X 50 | | 1528 | 2585 | 4117 | | | 4700 | 5000 |
| | M-X 30 | 3.30 | 1533 | 2455 | 4262 | 3.30 | 3.30 | 3000 | 3000 |
| | M-X 50 | | 1678 | 2735 | 4417 | | | 4700 | 5000 |
| | M-X 30 | 3.50 | 1633 | 2555 | 4462 | 3.50 | 3.50 | 3000 | 3000 |
| | M-X 50 | | 1778 | 2835 | 4617 | | | 4700 | 5000 |
| | M-X 30 | 3.70 | 1793 | 2715 | 4662 | 3.70 | 3.70 | 3000 | 3000 |
| | M-X 50 | | 1878 | 2935 | 4817 | | | 4700 | 5000 |
| | M-X 30 | 4.00 | 1983 | 2905 | 4962 | 4.00 | 4.00 | 3000 | 3000 |
| | M-X 50 | | 1978 | 3085 | 5517 | | | 4700 | 5000 |
| Full visibility triplex | M-X 30 | 5.50 | - | 3055 | 6725 | 4.00 | 4.00 | 1500 | 2000 |
| Free lift triplex | M-X 30 | 3.70 | 1283 | 2205 | 4662 | 3.70 | 3.70 | 3000 | 3000 |
| | M-X 50 | | 1265 | 2310 | 4805 | | | 4700 | 5000 |
| | M-X 30 | 4.00 | 1383 | 2305 | 4962 | 4.00 | 4.00 | 3000 | 3000 |
| | M-X 50 | | 1365 | 2410 | 5105 | | | 4700 | 4700 |
| | M-X 30 | 4.30 | 1533 | 2455 | 5262 | 4.00 | 4.30 | 2900 | 3000 |
| | M-X 50 | | 1465 | 2510 | 5404 | | 4.00 | 4050 | 4500 |
| | M-X 50 | 4.50 | 1540 | 2585 | 5605 | 4.00 | 4.00 | 3600 | 4000 |
| | M-X 30 | 4.70 | 1633 | 2555 | 5662 | 4.00 | 4.00 | 2600 | 2700 |
| | M-X 50 | | 1600 | 2645 | 5805 | | | 3350 | 3700 |
| | M-X 30 | 5.00 | 1793 | 2715 | 5962 | 4.00 | 4.00 | 2400 | 2600 |
| | M-X 50 | | 1715 | 2760 | 6105 | | | 3000 | 3300 |
| | M-X 30 | 5.50 | 1983 | 2905 | 6462 | 4.00 | 4.00 | 1500 | 2000 |
| | M-X 50 | | 1865 | 2910 | 6601 | | | 2150 | 2400 |
| | M-X 30 | 6.00 | 2233 | 3155 | 6962 | 4.00 | 4.00 | 1600 | 1800 |
| | M-X 50 | | 2040 | 3085 | 7105 | | | 1800 | 2000 |

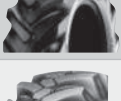
TYRES

M-X 30 / M-X 50 / M-X 70

| | | | Working envelope | Tyre width (mm) | Overall width (mm) | |
|-----------------|-----------------|-------|--|-----------------|--------------------|---|
| Standard | M-X 30-2 | Front | 14.5 R 20 - MPT80 TL 18 PR 143 G/J | 350 | 1900 |  |
| | | Rear | 10R17.5 G291 134M | 250 | 1822 |  |
| | M-X 30-4 | Front | 16.5 / 85 - 24 SGI 14PR | 435 | 2105 |  |
| | | Rear | 10.5 / 80 - 18 TG42 TL 10PR | 274 | 2034 |  |
| | M-X 50-2 | Front | 18-19.5 A224 18 PR TL | 457 | 2057 |  |
| | | Rear | 10R17.5 G291 134M | 250 | 1838 |  |
| | M-X 50-4 | Front | 18 - 22.5 MPT 06 16PR TL (445 / 65 R22.5) | 460 | 2080 |  |
| | | Rear | 340 / 80 - R18 XMCL TL 143A8 | 351 | 2091 |  |
| | M-X 70-2 | Front | 18 R 19.5 XF TL (445 / 65 R19.5) | 450 | 2150 |  |
| | | Rear | 265 / 70 R19.5 HTR1 | 275 | 1855 |  |
| Option | M-X 30-2 | Front | 380 / 75 R 20 XMCL TL 148A8 | 385 | 1935 |  |
| | M-X 30-4 | Rear | 12.0-18 T86 Tube type 12PR | 314 | 2074 |  |
| | | Rear | 10.5-18 12PR | 270 | 2030 |  |
| | M-X 50-2 | Front | 18 R 19.5 XF TL (445 / 65 R19.5) | 450 | 2050 |  |
| | M-X 50-4 | Front | 18 R 22.5 XF TL (445 / 65 R22.5) | 450 | 2070 |  |
| | M-X 70-2 | Front | 18 R 22.5 XF TL (445 / 65 R22.5) | 450 | 2150 |  |

APPLICATIONS





MANITOU SERVICES

M-X 30 / M-X 50 / M-X 70



Tailor-made finance to make the best use of your funds

You can plan the purchase of your forklift with peace of mind by using MANITOU' financing opportunities.

You will have simple solutions adapted to your needs and seasonal requirements. If you want to make a rapid investment, consider asking us for a personalised proposal to take your situation into account.

* MANITOU Finance solutions are available in certain countries.

MANITOU maintenance contract

2 levels of maintenance adapted to your needs. You are sure of:

- equipment always in good working condition
- a reduction of repair costs as a result of regular servicing
- authentic standardised services

- Labour
- Attendance costs



- Labour
- Attendance costs
- Parts and lubricants



MANIPLUS extension of guarantee

With MANIPLUS you can take out an extension of guarantee of 12 or 24 months.

EASY MANAGER

A simple and flexible system for fleet management (with or without geolocation) to provide optimum service from your machines. EASY MANAGER gives you:

- real-time materials management
- simple and easy way of managing your machinery activity and maintenance
- maximise your asset and safeguard your equipment



MANITOU spare parts

Utilising genuine MANITOU spare parts is sure to prolong the best performance capability of your machine. Your MANITOU dealer has access to a stock of 70,000 part numbers, available in 24 hours in Europe (48 hours outside Europe).



M-X30 M-X50 M-X70

| | M-X 30-2 | M-X 30-4 | M-X 50-2 | M-X 50-4 | M-X 70-2 |
|---|---|--------------------------------|--------------------------|--|-------------------------------------|
| Lifting | | | | | |
| Max. capacity | 3000 kg at 500 mm CDG | | 5000 kg at 600 mm CDG | | 7000 kg at 600 mm CDG |
| Lifting height (standard mast) | 3.70 m | | 3.70 m | | 4.00 m |
| Max. lifting height | 6.00 m | | 6.00 m | | 4.50 m |
| Unladen time (standard mast) | | | | | |
| Lifting | 0.6 m/s | | 0.4 m/s | | 0.4 m/s |
| Lowering | 0.5 m/s | | 0.4 m/s | | 0.4 m/s |
| Tyres | | | | | |
| Forward | 14.5 R 20 - MPT80 TL 18 PR 143 G/J | 16.5 / 85 - 24 SGI 14PR | 18-19.5 A224 18 PR TL | 18 - 22.5 MPT 06 16PR TL (445 / 65 R22.5) | 18 R 19.5 XF TL (445 / 65 R19.5) |
| Backward | 10R17.5 G291 134M | 10.5 / 80 - 18 TG42 TL 10PR | 10R17.5 G291 134M | 340 / 80 - R18 XMCL TL 143A8 | 265 / 70 R19.5 HTR1 |
| Braking | | | | | |
| Service brake | oil immersed multi-disc braking on the front axle | | | | |
| Parking brake | oil immersed multi-disc mechanics on the front axle | | | | |
| Engine | | | | | |
| PERKINS | | | | | |
| Type | 1104 D - 44 T - STAGE 3A | | | | |
| Cubic capacity | 4 cyl. - 4400 cm ³ | | | | |
| Power | 95 HP / 70 kW | | | | |
| Max. torque | 392 Nm at 1400 rpm | | | | |
| Injection | direct | | | | |
| Cooling | water | | | | |
| Laden drawbar pull | 4250 daN | 5870 daN | 6230 daN | 10360 daN | 7960 daN |
| Transmission | | | | | |
| torque converter | | | | | |
| Gearbox | mechanical | | | | Powershift |
| Reversing shift | electro-hydraulic | | | | |
| Number of gears (forward/reverse) | 4/4 | | | | 4/3 |
| Max. travel speed (may vary according to applicable regulations) | 24 km/h | 27 km/h | 22 km/h | 24 km/h | |
| Front axle differential lock | yes | no | yes | no | yes |
| Control for 2/4 wheel drive | no | yes | no | yes | no |
| Controls | | | | | |
| hydro-proportional levers for all movements | | | | | |
| Hydraulics | | | | | |
| 85 l/min - 185 bar | | 85 l/min - 210 bar | | 85 l/min - 230 bar | |
| Capacities | | | | | |
| Hydraulic oil | 64 l | | | | 108 l |
| Fuel | 85 l | | | | 115 l |
| Unladen weight (with standard mast and forks) | | | | | |
| 5430 kg | 5620 kg | 7470 kg | 7660 kg | 9810 kg | |
| Dimensions | | | | | |
| 1. Front wheel centre to carriage | 0.81 m | 0.81 m | 0.76 m | 0.76 m | 0.80 m |
| 2. Wheelbase | 2.10 m | 2.10 m | 2.12 m | 2.12 m | 2.49 m |
| 3. Rear wheel centre to rear face | 0.74 m | 0.74 m | 0.86 m | 0.86 m | 0.86 m |
| 4. Overall length to carriage | 3.63 m | 3.63 m | 3.75 m | 3.75 m | 4.16 m |
| 5. Ground clearance | 0,38 m | 0.40 m | 0,36 m | 0.38 m | 0.39 m |
| 6. Inside tyre width | 1.67 m | 1.67 m | 1.62 m | 1.62 m | 1.70 m |
| 7. Overall width | 2.10 m | 2.10 m | 2.10 m | 2.10 m | 2.15 m |
| 8. Overall height | 2,46 m | 2,54 m | 2,42 m | 2,50 m | 2,44 m |
| Standard forks (length x width x thickness) | 1200 x 125 x 40 mm | 1200 x 125 x 40 mm | 1200 x 150 x 60 mm | 1200 x 150 x 60 mm | 1200 x 150 x 70 mm |
| Turning radius | 4.10 m | 4.10 m | 4.16 m | 4.16 m | 4.21 m |
| Tilt standard mast (forward/backward) | 6° / 12° | | 6° / 12° | | 15° / 15° |
| Noise and vibration | | | | | |
| Noise at driving position (LpA) | 72 dB | | 76 dB | | |
| Environmental noise (LwA) | 104 dB | | 103 dB | | |
| Vibration to whole hand/arm | <2.5 m/s ² | | | | |

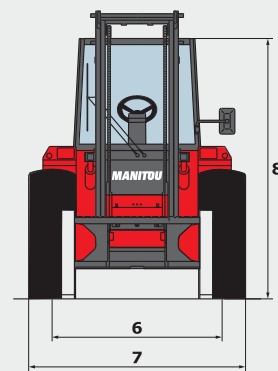
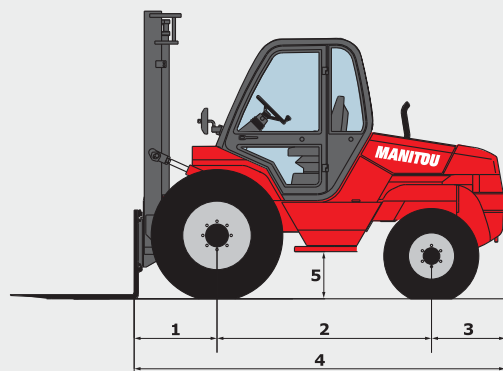

M-X30 M-X50 M-X70

Charts without sideshift attachment

M-X 30

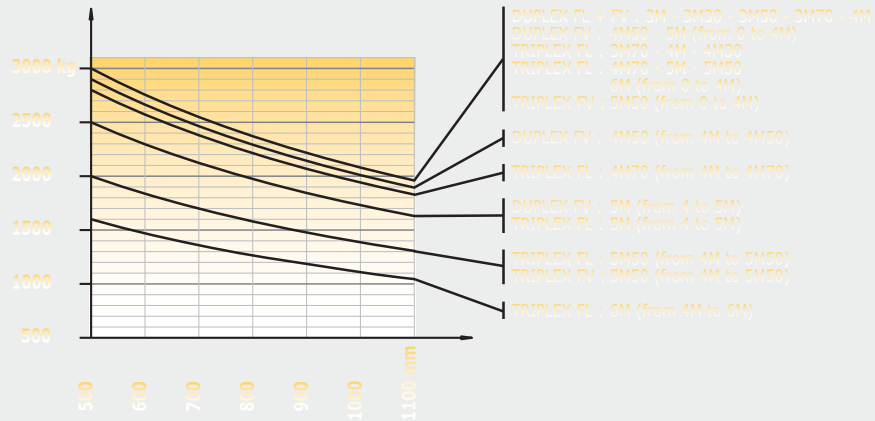

M-X 50

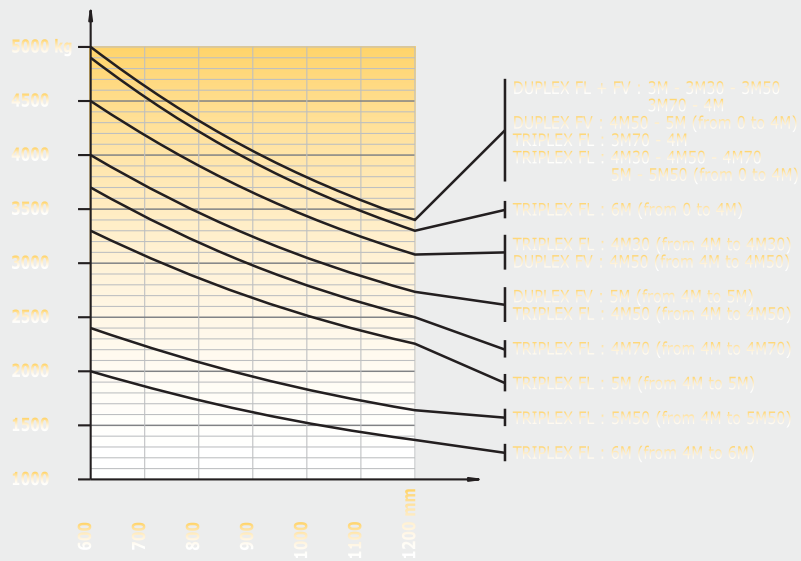

M-X 70

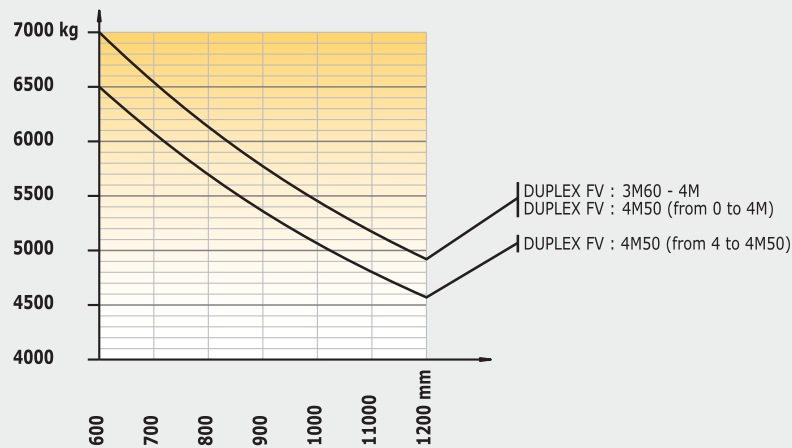

FV = Full Visibility
FL = Free Lift

This brochure describes versions and configuration options for Manitou products which may be fitted with different equipment. The equipment described in this brochure may be standard, optional or not available depending on version. Manitou reserves the right to change the specifications shown and described at any time and without prior warning. The manufacturer is not liable for the specifications given. For more information, contact your Manitou dealer. Non-contractual document. Product descriptions may differ from actual products. List of specifications is not comprehensive. The logos and visual identity of the company are the property of Manitou and may not be used without authorisation. All rights reserved. The photos and diagrams contained in this brochure are provided for information only.

MANITOU BF SA - Limited company with board of directors - Share capital: 39,547,824 euros - 857 802 508 RCS Nantes



M-X30 M-X50 M-X70

Charts with sideshift attachment

M-X 30

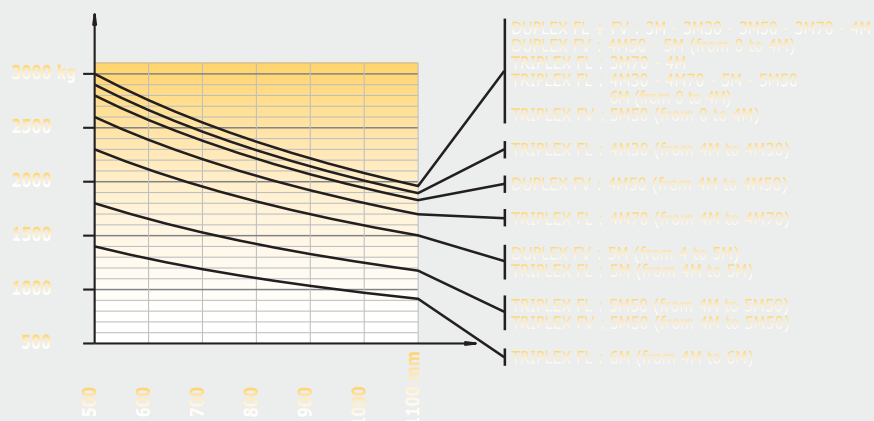

M-X 50

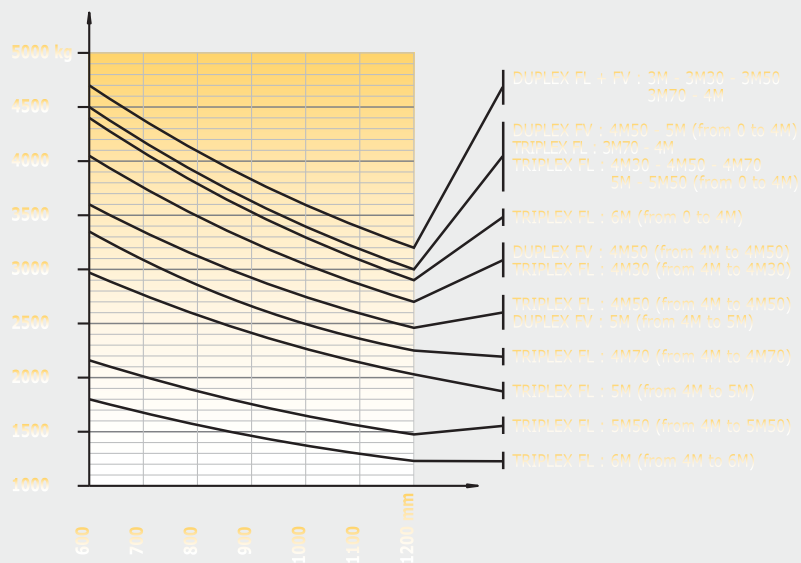

M-X 70

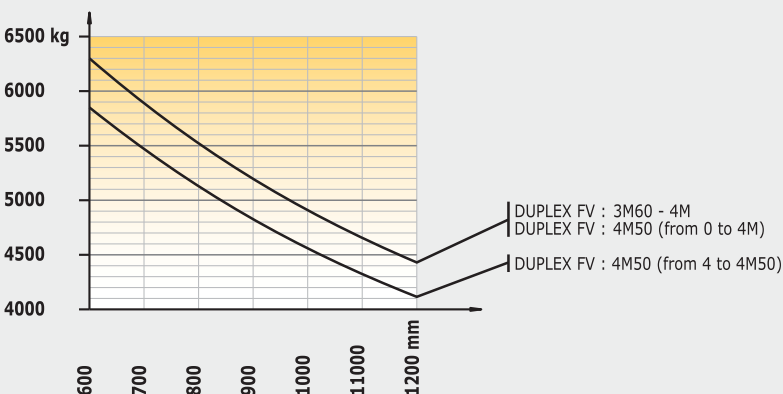

FV = Full Visibility
FL = Free Lift

This brochure describes versions and configuration options for Manitou products which may be fitted with different equipment. The equipment described in this brochure may be standard, optional or not available depending on version. Manitou reserves the right to change the specifications shown and described at any time and without prior warning. The manufacturer is not liable for the specifications given. For more information, contact your Manitou dealer. Non-contractual document. Product descriptions may differ from actual products. List of specifications is not comprehensive. The logos and visual identity of the company are the property of Manitou and may not be used without authorisation. All rights reserved. The photos and diagrams contained in this brochure are provided for information only.
MANITOU BF SA - Limited company with board of directors - Share capital: 39,547,824 euros - 857 802 508 RCS Nantes



Your nearest **MANITOU** dealer:



www.agripakgroup.com



Head office:

B.P. 249 - 430 rue de l'Aubinière - 44158 Ancenis Cedex - France

Tel: 00 33 (0)2 40 09 10 11 - Fax: 00 33 (0)2 40 09 10 97

www.manitou.com